

# 200 kPa On-Chip Temperature Compensated & Calibrated Pressure Sensors

The MPX2200 series device is a silicon piezoresistive pressure sensor providing a highly accurate and linear voltage output — directly proportional to the applied pressure. The sensor is a single monolithic silicon diaphragm with the strain gauge and a thin-film resistor network integrated on-chip. The chip is laser trimmed for precise span and offset calibration and temperature compensation. They are designed for use in applications such as pump/motor controllers, robotics, level indicators, medical diagnostics, pressure switching, barometers, altimeters, etc.

**Features**

- Temperature Compensated Over 0°C to +85°C
- ±0.25% Linearity (MPX2200D)
- Easy-to-Use Chip Carrier Package Options
- Available in Absolute, Differential and Gauge Configurations

**Application Examples**

- Pump/Motor Controllers
- Robotics
- Level Indicators
- Medical Diagnostics
- Pressure Switching
- Barometers
- Altimeters

Figure 1 illustrates a block diagram of the internal circuitry on the stand-alone pressure sensor chip.

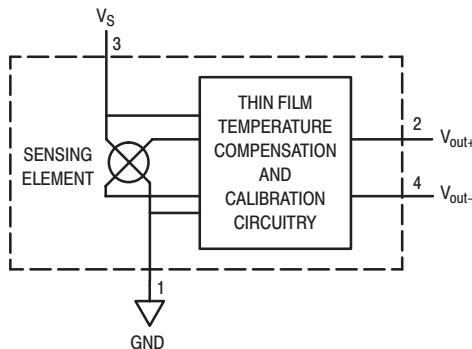

**Figure 1. Temperature Compensated Pressure Sensor Schematic**

**VOLTAGE OUTPUT versus APPLIED DIFFERENTIAL PRESSURE**

The differential voltage output of the sensor is directly proportional to the differential pressure applied.

The absolute sensor has a built-in reference vacuum. The output voltage will decrease as vacuum, relative to ambient, is drawn on the pressure (P1) side.

The output voltage of the differential or gauge sensor increases with increasing pressure applied to the pressure (P1) side relative to the vacuum (P2) side. Similarly, output voltage increases as increasing vacuum is applied to the vacuum (P2) side relative to the pressure (P1) side.

## MPX2200 SERIES

**0 to 200 kPa (0 to 29 psi)  
 40 mV FULL SCALE SPAN  
 (TYPICAL)**

**UNIBODY PACKAGE**

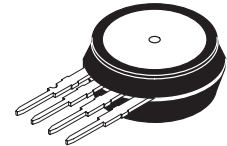

**MPX2200A/D  
 CASE 344**

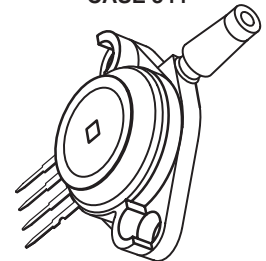

**MPX2200AP/GP  
 CASE 344B**

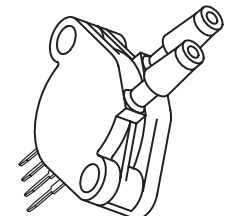

**MPX2200DP  
 CASE 344C**

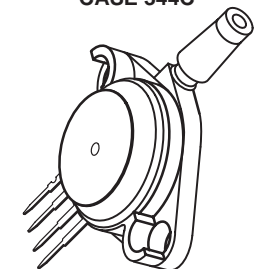

**MPX2200GVP  
 CASE 344D**

**PIN NUMBER**

1	Gnd	3	V <sub>S</sub>
2	+V <sub>out</sub>	4	-V <sub>out</sub>

NOTE: Pin 1 is noted by the notch in the lead.

## MAXIMUM RATINGS(NOTE)

Rating	Symbol	Value	Unit
Maximum Pressure (P1 > P2)	P <sub>max</sub>	800	kPa
Storage Temperature	T <sub>stg</sub>	-40 to +125	°C
Operating Temperature	T <sub>A</sub>	-40 to +125	°C

NOTE: Exposure beyond the specified limits may cause permanent damage or degradation to the device.

OPERATING CHARACTERISTICS (V<sub>S</sub> = 10 Vdc, T<sub>A</sub> = 25°C unless otherwise noted, P1 > P2)

Characteristics	Symbol	Min	Typ	Max	Unit
Pressure Range <sup>(1)</sup>	P <sub>OP</sub>	0	—	200	kPa
Supply Voltage	V <sub>S</sub>	—	10	16	Vdc
Supply Current	I <sub>o</sub>	—	6.0	—	mAdc
Full Scale Span <sup>(3)</sup>	V <sub>FSS</sub>	38.5	40	41.5	mV
Offset <sup>(4)</sup>	V <sub>off</sub>	-1.0	—	1.0	mV
Sensitivity	ΔV/ΔP	—	0.2	—	mV/kPa
Linearity <sup>(5)</sup>	MPX2200D Series MPX2200A Series	-0.25 -1.0	— —	0.25 1.0	%V <sub>FSS</sub>
Pressure Hysteresis <sup>(5)</sup> (0 to 200 kPa)	—	—	±0.1	—	%V <sub>FSS</sub>
Temperature Hysteresis <sup>(5)</sup> (-40°C to +125°C)	—	—	±0.5	—	%V <sub>FSS</sub>
Temperature Effect on Full Scale Span <sup>(5)</sup>	TCV <sub>FSS</sub>	-1.0	—	1.0	%V <sub>FSS</sub>
Temperature Effect on Offset <sup>(5)</sup>	TCV <sub>off</sub>	-1.0	—	1.0	mV
Input Impedance	Z <sub>in</sub>	1300	—	2500	Ω
Output Impedance	Z <sub>out</sub>	1400	—	3000	Ω
Response Time <sup>(6)</sup> (10% to 90%)	t <sub>R</sub>	—	1.0	—	ms
Warm-Up	—	—	20	—	ms
Offset Stability <sup>(7)</sup>	—	—	±0.5	—	%V <sub>FSS</sub>

## NOTES:

- 1.0 kPa (kiloPascal) equals 0.145 psi.
- Device is ratiometric within this specified excitation range. Operating the device above the specified excitation range may induce additional error due to device self-heating.
- Full Scale Span (V<sub>FSS</sub>) is defined as the algebraic difference between the output voltage at full rated pressure and the output voltage at the minimum rated pressure.
- Offset (V<sub>off</sub>) is defined as the output voltage at the minimum rated pressure.
- Accuracy (error budget) consists of the following:
  - Linearity: Output deviation from a straight line relationship with pressure, using end point method, over the specified pressure range.
  - Temperature Hysteresis: Output deviation at any temperature within the operating temperature range, after the temperature is cycled to and from the minimum or maximum operating temperature points, with zero differential pressure applied.
  - Pressure Hysteresis: Output deviation at any pressure within the specified range, when this pressure is cycled to and from the minimum or maximum rated pressure, at 25°C.
  - TcSpan: Output deviation at full rated pressure over the temperature range of 0 to 85°C, relative to 25°C.
  - TcOffset: Output deviation with minimum rated pressure applied, over the temperature range of 0 to 85°C, relative to 25°C.
- Response Time is defined as the time for the incremental change in the output to go from 10% to 90% of its final value when subjected to a specified step change in pressure.
- Offset stability is the product's output deviation when subjected to 1000 hours of Pulsed Pressure, Temperature Cycling with Bias Test.

**LINEARITY**

Linearity refers to how well a transducer's output follows the equation:  $V_{out} = V_{off} + \text{sensitivity} \times P$  over the operating pressure range. There are two basic methods for calculating nonlinearity: (1) end point straight line fit (see Figure 2) or (2) a least squares best line fit. While a least squares fit gives the "best case" linearity error (lower numerical value), the calculations required are burdensome.

Conversely, an end point fit will give the "worst case" error (often more desirable in error budget calculations) and the calculations are more straightforward for the user. Motorola's specified pressure sensor linearities are based on the end point straight line method measured at the midrange pressure.

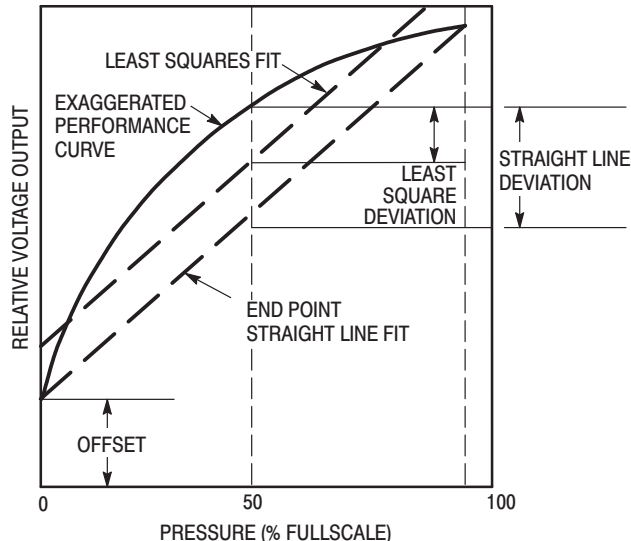

Figure 2. Linearity Specification Comparison

**ON-CHIP TEMPERATURE COMPENSATION and CALIBRATION**

Figure 3 shows the output characteristics of the MPX2200 series at 25°C. The output is directly proportional to the differential pressure and is essentially a straight line.

The effects of temperature on Full Scale Span and Offset are very small and are shown under Operating Characteristics.

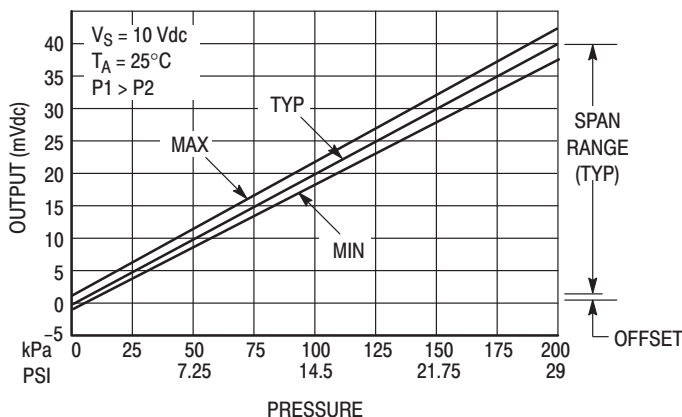

Figure 3. Output versus Pressure Differential

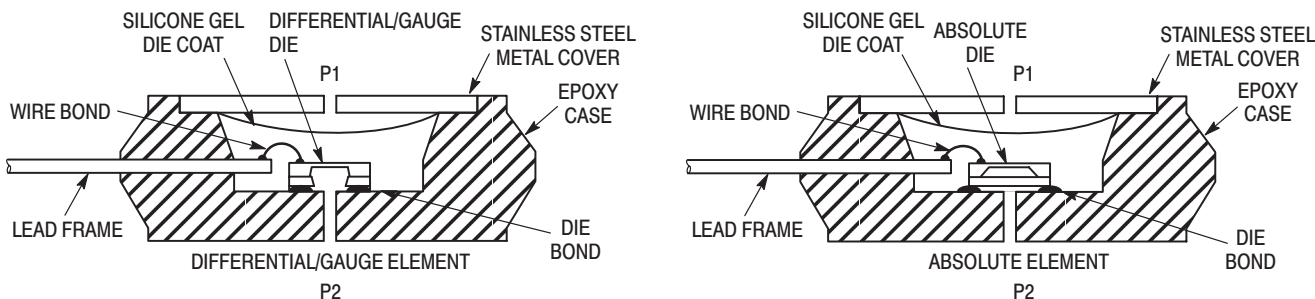

Figure 4. Cross-Sectional Diagrams (Not to Scale)

Figure 4 illustrates an absolute sensing die (right) and the differential or gauge die in the basic chip carrier (Case 344). A silicone gel isolates the die surface and wire bonds from the environment, while allowing the pressure signal to be transmitted to the silicon diaphragm.

The MPX2200 series pressure sensor operating charac-

teristics and internal reliability and qualification tests are based on use of dry air as the pressure media. Media other than dry air may have adverse effects on sensor performance and long term reliability. Contact the factory for information regarding media compatibility in your application.

## PRESSURE (P1)/VACUUM (P2) SIDE IDENTIFICATION TABLE

Motorola designates the two sides of the pressure sensor as the Pressure (P1) side and the Vacuum (P2) side. The Pressure (P1) side is the side containing the silicone gel which isolates the die from the environment. The differential or gauge sensor is designed to operate with positive differen-

tial pressure applied,  $P1 > P2$ . The absolute sensor is designed for vacuum applied to P1 side.

The Pressure (P1) side may be identified by using the table below:

Part Number		Case Type	Pressure (P1) Side Identifier
MPX2200A	MPX2200D	344	Stainless Steel Cap
MPX2200DP		344C	Side with Part Marking
MPX2200AP	MPX2200GP	344B	Side with Port Attached
MPX2200GVP		344D	Stainless Steel Cap

## ORDERING INFORMATION

MPX2200 series pressure sensors are available in absolute, differential and gauge configurations. Devices are available in the basic element package or with pressure port fittings which provide printed circuit board mounting ease and barbed hose pressure connections.

Device Type	Options	Case Type	MPX Series	
			Order Number	Device Marking
Basic Element	Absolute, Differential	344	MPX2200A MPX2200D	MPX2200A MPX2200D
Ported Elements	Differential	344C	MPX2200DP	MPX2200DP
	Absolute, Gauge	344B	MPX2200AP MPX2200GP	MPX2200AP MPX2200GP
	Gauge, Vacuum	344D	MPX2200GVP	MPX2200GVP

**PACKAGE DIMENSIONS**

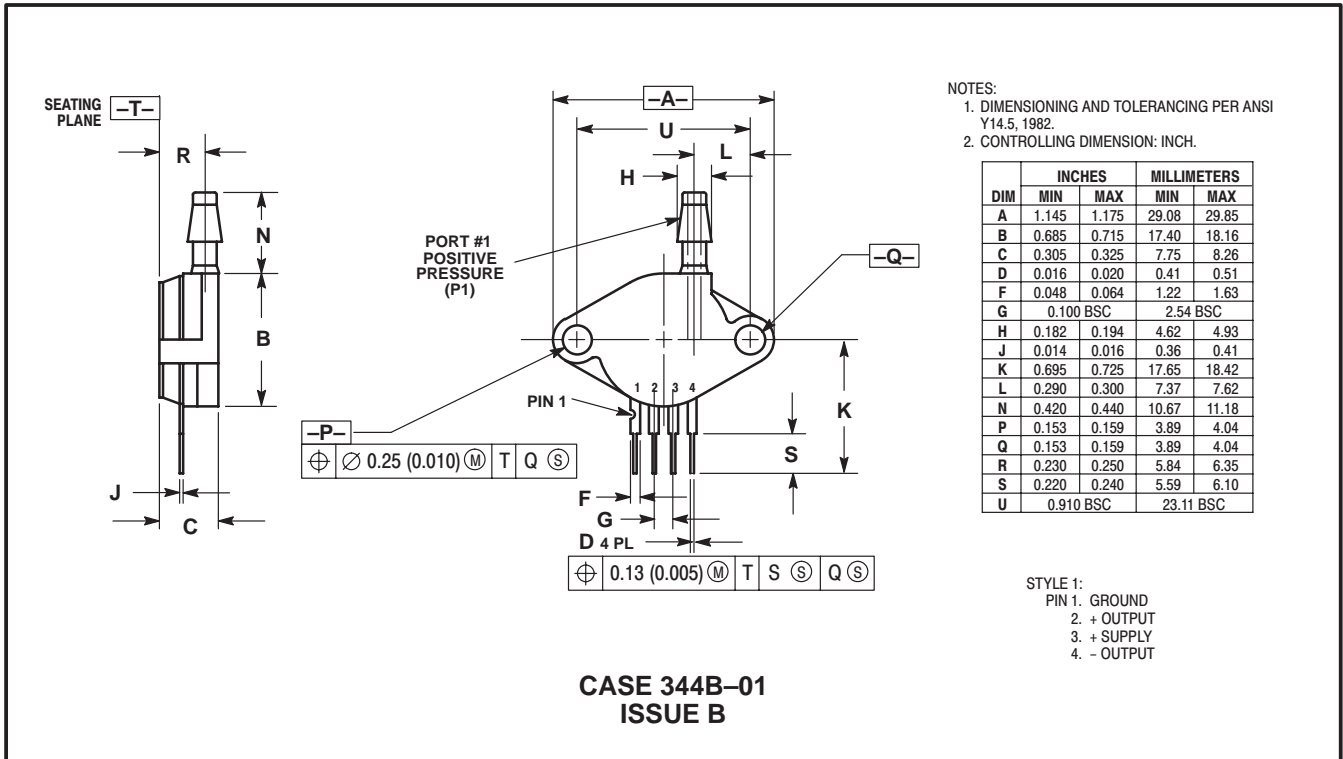
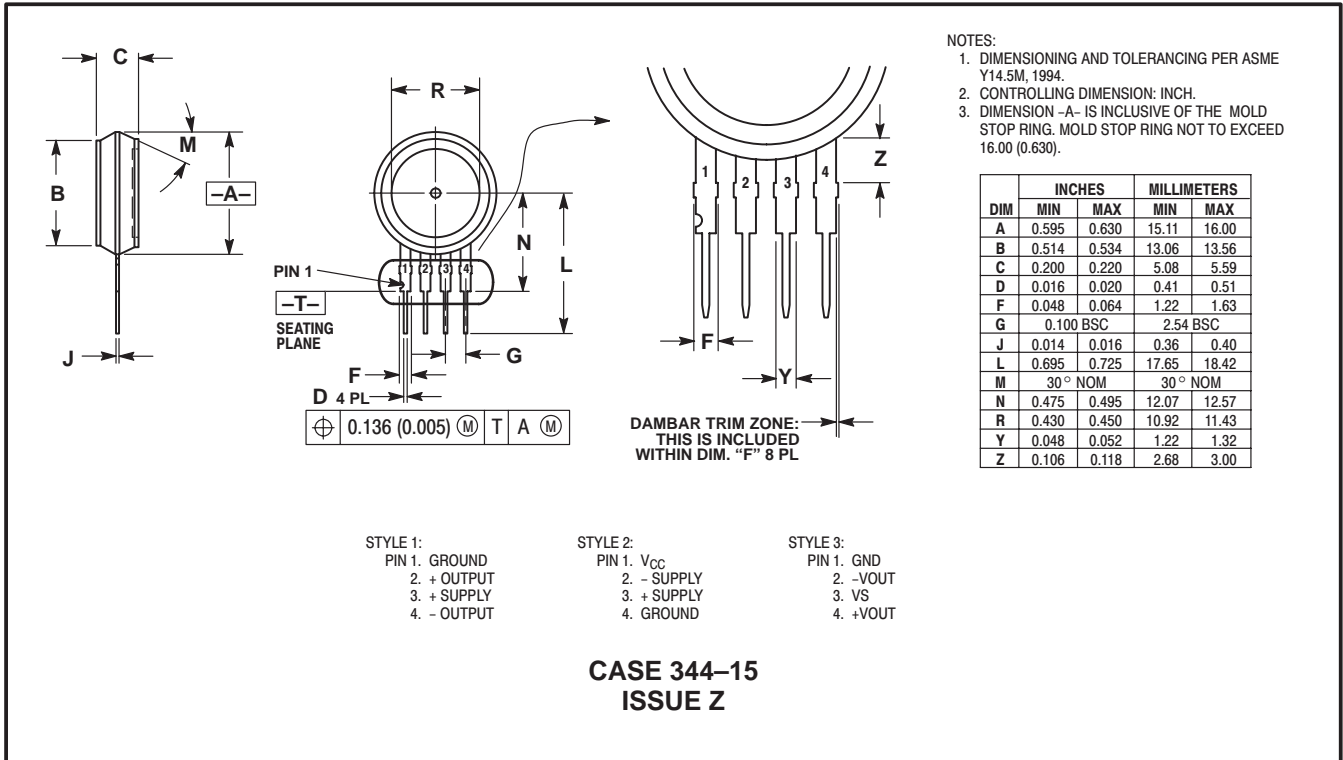

PACKAGE DIMENSIONS — CONTINUED

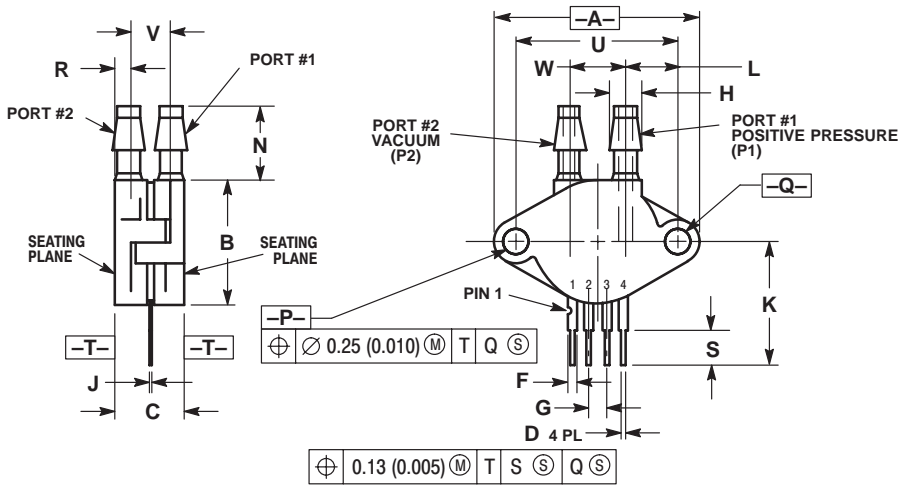

NOTES:  
 1. DIMENSIONING AND TOLERANCING PER ANSI Y14.5M, 1982.  
 2. CONTROLLING DIMENSION: INCH.

DIM	INCHES		MILLIMETERS	
	MIN	MAX	MIN	MAX
A	1.145	1.175	29.08	29.85
B	0.685	0.715	17.40	18.16
C	0.405	0.435	10.29	11.05
D	0.016	0.020	0.41	0.51
F	0.048	0.064	1.22	1.63
G	0.100 BSC		2.54 BSC	
H	0.182	0.194	4.62	4.93
J	0.014	0.016	0.36	0.41
K	0.695	0.725	17.65	18.42
L	0.290	0.300	7.37	7.62
N	0.420	0.440	10.67	11.18
P	0.153	0.159	3.89	4.04
Q	0.153	0.159	3.89	4.04
R	0.063	0.083	1.60	2.11
S	0.220	0.240	5.59	6.10
U	0.910 BSC		23.11 BSC	
V	0.248	0.278	6.30	7.06
W	0.310	0.330	7.87	8.38

STYLE 1:  
 PIN 1. GROUND  
 2. + OUTPUT  
 3. + SUPPLY  
 4. - OUTPUT

CASE 344C-01  
 ISSUE B

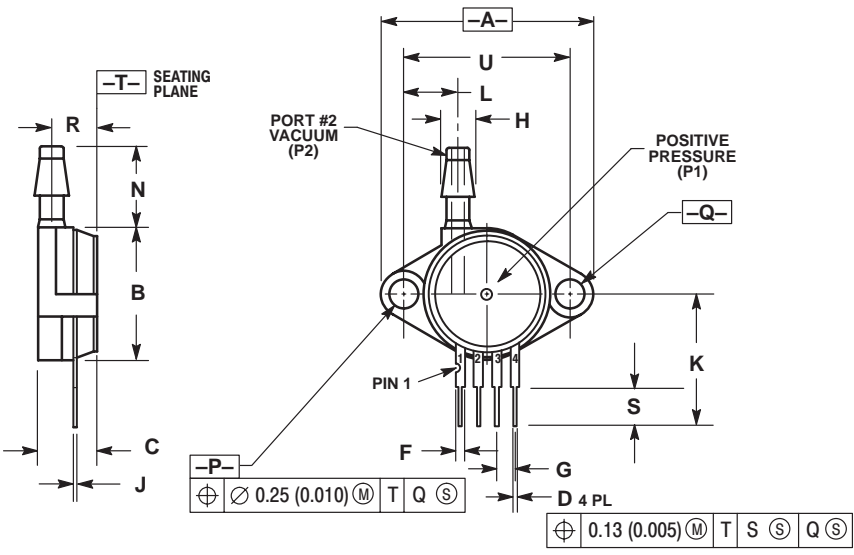

NOTES:  
 1. DIMENSIONING AND TOLERANCING PER ANSI Y14.5, 1982.  
 2. CONTROLLING DIMENSION: INCH.

DIM	INCHES		MILLIMETERS	
	MIN	MAX	MIN	MAX
A	1.145	1.175	29.08	29.85
B	0.685	0.715	17.40	18.16
C	0.305	0.325	7.75	8.26
D	0.016	0.020	0.41	0.51
F	0.048	0.064	1.22	1.63
G	0.100 BSC		2.54 BSC	
H	0.182	0.194	4.62	4.93
J	0.014	0.016	0.36	0.41
K	0.695	0.725	17.65	18.42
L	0.290	0.300	7.37	7.62
N	0.420	0.440	10.67	11.18
P	0.153	0.159	3.89	4.04
Q	0.153	0.158	3.89	4.04
R	0.230	0.250	5.84	6.35
S	0.220	0.240	5.59	6.10
U	0.910 BSC		23.11 BSC	

STYLE 1:  
 PIN 1. GROUND  
 2. + OUTPUT  
 3. + SUPPLY  
 4. - OUTPUT

CASE 344D-01  
 ISSUE B

**NOTES**

**Freescale Semiconductor, Inc.**

Motorola reserves the right to make changes without further notice to any products herein. Motorola makes no warranty, representation or guarantee regarding the suitability of its products for any particular purpose, nor does Motorola assume any liability arising out of the application or use of any product or circuit, and specifically disclaims any and all liability, including without limitation consequential or incidental damages. "Typical" parameters can and do vary in different applications and actual performance may vary over time. All operating parameters, including "Typicals" must be validated for each customer application by customer's technical experts. Motorola does not convey any license under its patent rights nor the rights of others. Motorola products are not designed, intended, or authorized for use as components in systems intended for surgical implant into the body, or other applications intended to support or sustain life, or for any other application in which the failure of the Motorola product could create a situation where personal injury or death may occur. Should Buyer purchase or use Motorola products for any such unintended or unauthorized application, Buyer shall indemnify and hold Motorola and its officers, employees, subsidiaries, affiliates, and distributors harmless against all claims, costs, damages, and expenses, and reasonable attorney fees arising out of, directly or indirectly, any claim of personal injury or death associated with such unintended or unauthorized use, even if such claim alleges that Motorola was negligent regarding the design or manufacture of the part. Motorola and the Stylized M Logo are registered trademarks of Motorola, Inc. Motorola, Inc. is an Equal Opportunity/Affirmative Action Employer.

MOTOROLA and the Stylized M Logo are registered in the US Patent & Trademark Office. All other product or service names are the property of their respective owners.

© Motorola, Inc. 2002.

**How to reach us:**

**USA/EUROPE/Locations Not Listed:** Motorola Literature Distribution; P.O. Box 5405, Denver, Colorado 80217. 1-303-675-2140 or 1-800-441-2447

**JAPAN:** Motorola Japan Ltd.; SPS, Technical Information Center, 3-20-1, Minami-Azabu, Minato-ku, Tokyo 106-8573 Japan. 81-3-3440-3569

**ASIA/PACIFIC:** Motorola Semiconductors H.K. Ltd.; Silicon Harbour Centre, 2 Dai King Street, Tai Po Industrial Estate, Tai Po, N.T., Hong Kong. 852-26668334

**Technical Information Center: 1-800-521-6274**

**HOME PAGE:** <http://www.motorola.com/semiconductors/>



**MOTOROLA**

**For More Information On This Product,  
Go to: [www.freescale.com](http://www.freescale.com)**

MPX2200D/D