

T-41-83

HIGH-VOLTAGE OPTOCOUPLER

The CNX62 is an optocoupler consisting of an infrared emitting GaAs diode and a silicon npn phototransistor in a dual-in-line (DIL) plastic envelope. The base is not connected.

Features

- High current transfer ratio and a low saturation voltage suitable for use with TTL integrated circuits
- High degree of AC and DC insulation (3750 V RMS and 5300 V DC)
- Working voltage of 2.5 kV (DC)

UL — Covered under UL component recognition FILE E90700

VDE — Approved according to VDE 0883/6.80
Reference voltage (VDE 0110b Tab 4): AC 500 V/DC 600 V — ←

Complied for reinforced isolation at 250 V AC with:
DIN 57 804/VDE 0804/1.83 (isolation group C) ←
DIN VDE 0860/8.86/HD 195 S4 ←

BSI — Certification according to BS415:1979 (Home appliance) ←

QUICK REFERENCE DATA

Diode

Continuous reverse voltage	V_R	max.	5 V
DC forward current	I_F	max.	100 mA
peak value; $t_{on} = 10 \mu s$; $\delta = 0.01$	I_{FRM}	max.	3 A
Total power dissipation up to $T_{amb} = 25^\circ C$	P_{tot}	max.	200 mW

Transistor

Collector-emitter voltage (open base)	V_{CEO}	max.	50 V
Total power dissipation up to $T_{amb} = 25^\circ C$	P_{tot}	max.	200 mW

Optocoupler

Output/input DC current transfer ratio (CTR) $I_F = 10 \text{ mA}$; $V_{CE} = 0.4 \text{ V}$	I_C/I_F	min.	0.4
Collector cut-off current (dark) $V_{CC} = 10 \text{ V}$; working voltage = 2.5 kV DC I_F (diode) = 0 (see Fig.4)	I_{CEW}	max.	200 nA
Collector-emitter saturation voltage $I_F = 10 \text{ mA}$; $I_C = 4 \text{ mA}$	V_{CEsat}	max.	0.4 V
Isolation voltage DC	V_{IORM}	min.	5.3 kV
AC (RMS value)		min.	3.75 kV

MECHANICAL DATA

SOT174 (see Fig.1).

T-41-83

MECHANICAL DATA

Dimensions in mm

Fig.1 SOT174.

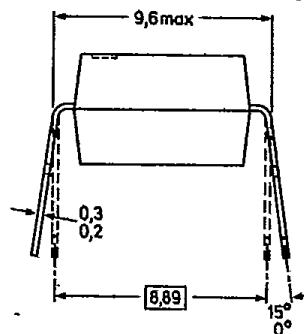
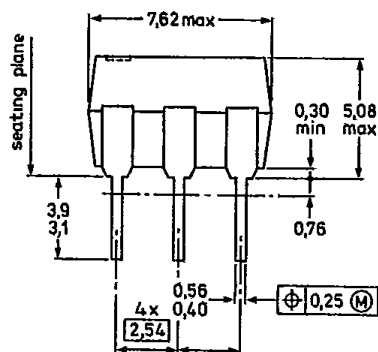

7Z85851A

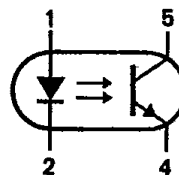
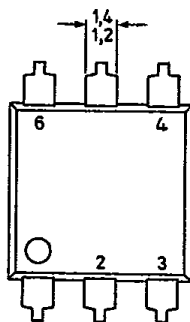

The base is not connected.

RATINGS

Limiting values in accordance with the Absolute Maximum System (IEC 134)

Diode

Continuous reverse voltage	V_R	max.	5 V
DC forward current	I_F	max.	100 mA
peak value; $t_{on} = 10 \mu s$; $\delta = 0.01$	I_{FRM}	max.	3 A
Total power dissipation up to $T_{amb} = 25 \text{ }^\circ\text{C}$ (when mounted on a printed circuit board: $T_{amb} = 45 \text{ }^\circ\text{C}$)	P_{tot}	max.	200 mW

Transistor

Collector-emitter voltage (open base)	V_{CEO}	max.	50 V
Emitter-collector voltage	V_{ECO}	max.	7 V
DC collector current	I_C	max.	100 mA
Total power dissipation up to $T_{amb} = 25 \text{ }^\circ\text{C}$ (when mounted on a printed circuit board: $T_{amb} = 45 \text{ }^\circ\text{C}$)	P_{tot}	max.	200 mW

Optocoupler

Storage temperature range	T_{stg}	=	-55 to + 150 °C
Junction temperature	T_j	max.	125 °C
Soldering temperature up to the seating plane; $t_{sld} < 10$ s	T_{sld}	max.	260 °C

THERMAL RESISTANCE

From junction to ambient in free air			
diode	$R_{th\ j-a}$	=	500 K/W
transistor	$R_{th\ j-a}$	=	500 K/W
From junction to ambient when mounted on PCB			
diode	$R_{th\ j-a}$	=	400 K/W
transistor	$R_{th\ j-a}$	=	400 K/W

ISOLATION RELATED VALUES

External air gap (clearance) input terminals to output terminals	L(IO1)	min.	8.4 mm
External tracking path (creepage distance) input terminals to output terminals	L(IO2)	min.	7.0 mm
Tracking resistance (KB-value)			KB-100/A
Internal plastic gap (clearance) isolation thickness between emitter and receiver		min.	1 mm ←

CHARACTERISTICS

$T_j = 25$ °C unless otherwise specified

Diode

Forward voltage $I_F = 10$ mA	V_F	typ.	1.15 V
		max.	1.50 V
Reverse current $V_R = 5$ V	I_R	max.	10 μ A

Transistor

Collector-emitter breakdown voltage $I_C = 1$ mA	$V_{(BR)CEO}$	min.	50 V
Emitter-collector breakdown voltage $I_E = 0.1$ mA	$V_{(BR)ECO}$	min.	7 V
Collector cut-off current (dark); diode $I_F = 0$ $V_{CE} = 10$ V	I_{CEO}	typ.	2 nA
		max.	50 nA
$V_{CE} = 10$ V; $T_{amb} = 70$ °C	I_{CEO}	max.	10 μ A

Optocoupler

Output/input DC current transfer ratio (CTR) $I_F = 10$ mA; $V_{CE} = 0.4$ V	I_C/I_F	min.	0.4
		typ.	0.8
$I_F = 10$ mA; $V_{CE} = 5$ V	I_C/I_F	typ.	1.5
Collector cut-off current (light) $T_{amb} \leq 70$ °C; $V_F = 0.8$ V; $V_{CE} = 15$ V	$I_{CE(L)}$	max.	15 μ A
$T_{amb} \leq 70$ °C; $I_F = 2$ mA; $V_{CE} = 0.4$ V	$I_{CE(L)}$	min.	150 μ A

Optocoupler (continued)

Collector-emitter saturation voltage

$I_F = 10 \text{ mA}; I_C = 4 \text{ mA}$

V_{CEsat}	typ.	0.19 V
	max.	0.40 V

Collector cut-off current (dark) at working voltage 2.5 kV DC;

$V_{CC} = 10 \text{ V}; T_j = 25 \text{ }^\circ\text{C}$ (see Fig.4 and notes 1 and 2)

$V_{CC} = 10 \text{ V}; T_j = 70 \text{ }^\circ\text{C}$ (see Fig.4 and notes 1 and 2)

I_{CEW}	max.	200 nA
	max.	100 μA

Isolation voltage; $t = 1 \text{ min}$
(see note 3)

DC
AC (RMS value)

V_{IORM}	min.	5.3 kV
	min.	3.75 kV

Capacitance between input and output

$V = 0; f = 1 \text{ MHz}$

C_{io}	typ.	0.6 pF
----------	------	--------

Insulation resistance between input and output

$V_{IO} = \pm 1000 \text{ V}$

R_{IO}	min.	10 G Ω
	typ.	1 T Ω

Switching times (see Figs 2 and 3)

Turn-on time

$I_C = 2 \text{ mA}; V_{CC} = 5 \text{ V}; R_L = 100 \Omega$

$I_C = 2 \text{ mA}; V_{CC} = 5 \text{ V}; R_L = 1 \text{ k}\Omega$

t_{on}	typ.	3 μs
	typ.	12 μs

Turn-off time

$I_C = 2 \text{ mA}; V_{CC} = 5 \text{ V}; R_L = 100 \Omega$

$I_C = 2 \text{ mA}; V_{CC} = 5 \text{ V}; R_L = 1 \text{ k}\Omega$

t_{off}	typ.	3 μs
	typ.	12 μs

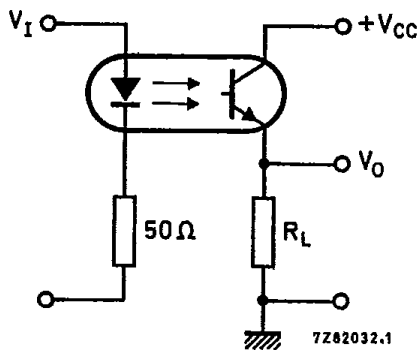

Fig.2 Switching circuit.

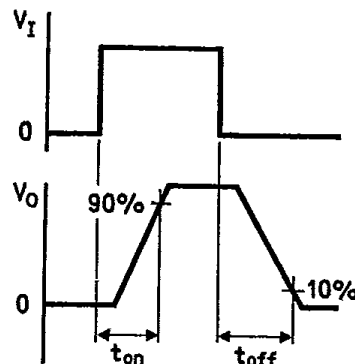

Fig.3 Waveforms.

Notes

1. The two parameters are tested on a sample basis for 1000 h.
2. This parameter is the maximum collector-emitter leakage current measured when a high voltage is applied between the shorted diode leads and the transistor emitter.
3. Every single product is tested by applying an isolation test voltage of 4500 V (RMS) for 2 seconds between the shorted input (diode) leads and the shorted output (phototransistor) leads.

T-41-83

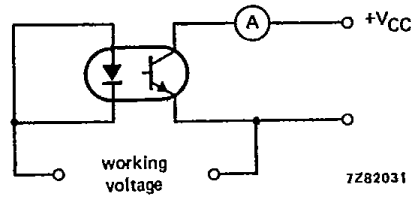

Fig. 4.

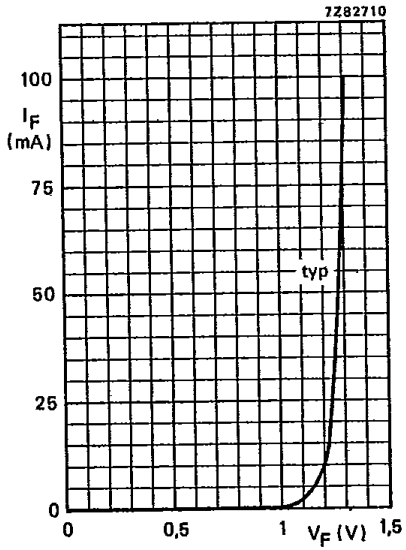

Fig. 5 $T_{amb} = 25\text{ }^{\circ}\text{C}$.

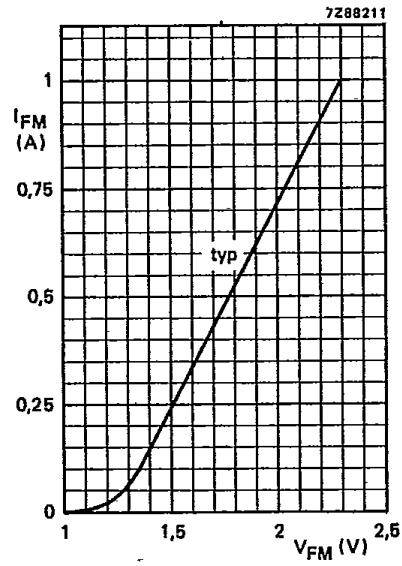

Fig. 6 $T_{amb} = 25\text{ }^{\circ}\text{C}$; $t_p = 10\text{ }\mu\text{s}$; $\delta = 0.01$.

T-41-83

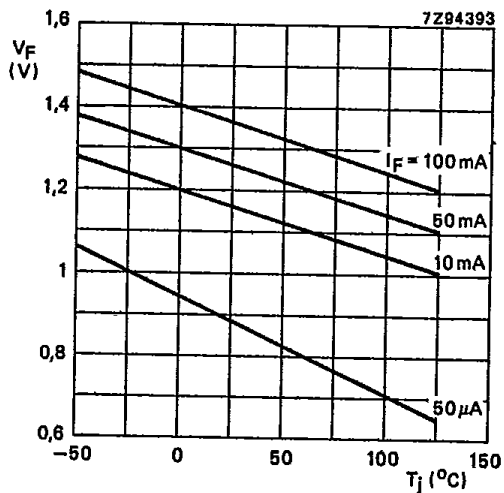

Fig.7 Typical values.

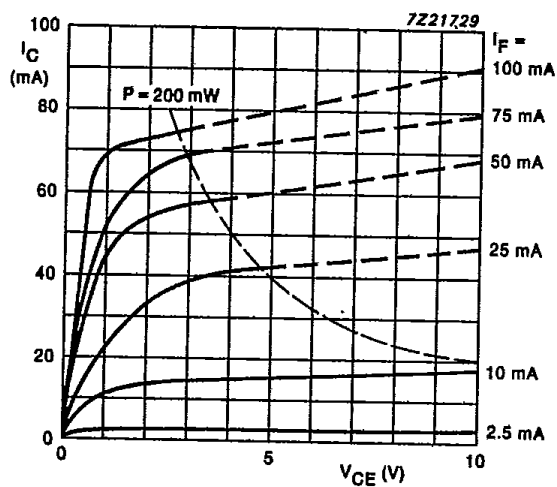

Fig.8 Typical values; $T_{amb} = 25 \text{ }^\circ\text{C}$.

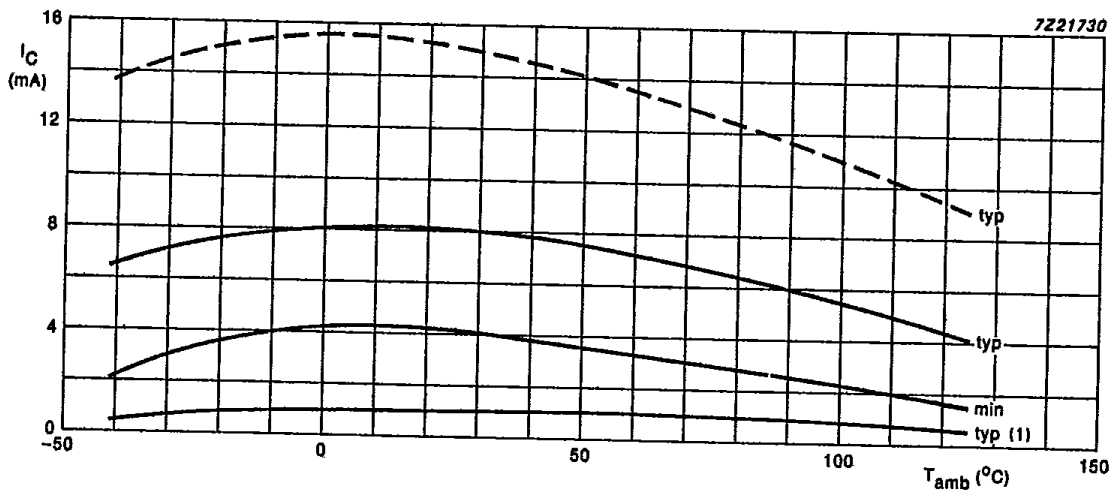

Fig.9 $I_F = 10 \text{ mA}$; — $V_{CE} = 0.4 \text{ V}$; - - - $V_{CE} = 5 \text{ V}$.

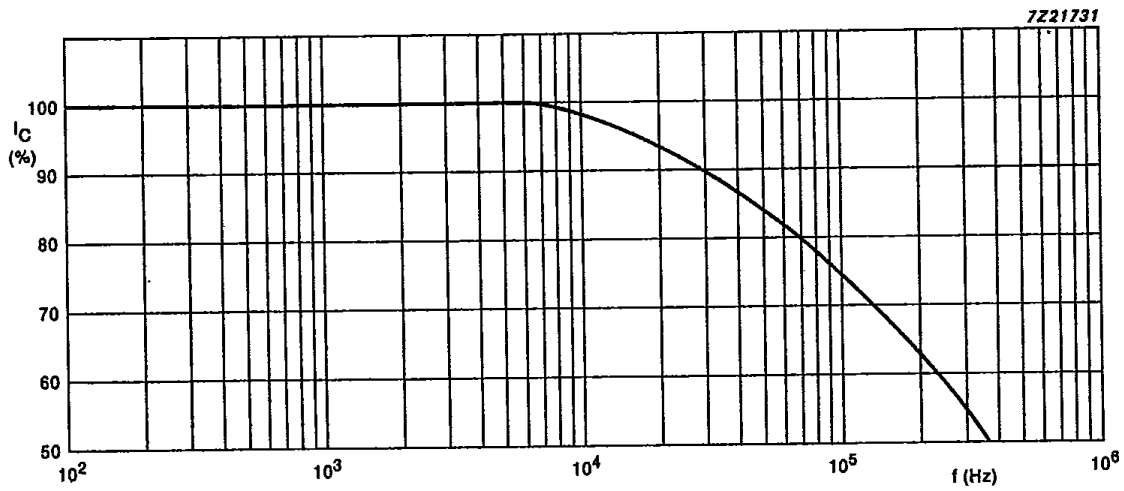

Fig.10 Typical values; R_L = 1 kΩ; I_C = 2 mA; V_{CC} = 5 V; T_{amb} = 25 °C.

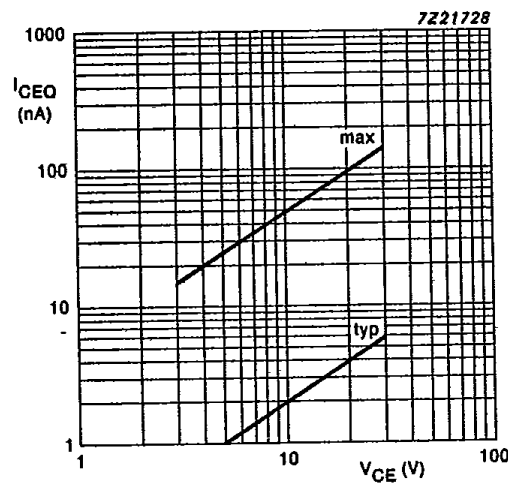

Fig.11 T_j = 25 °C.

T-41-83

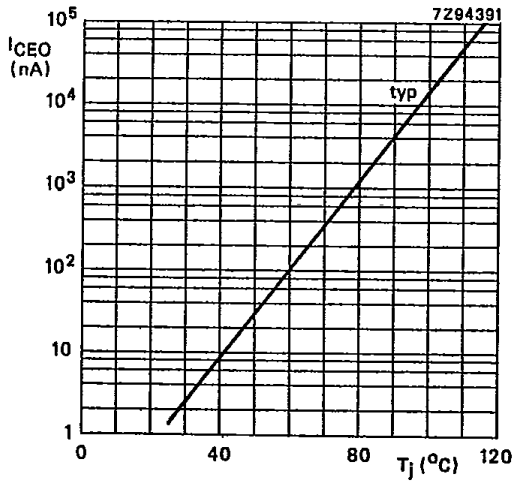

Fig. 12 $V_{CE} = 10 V$.

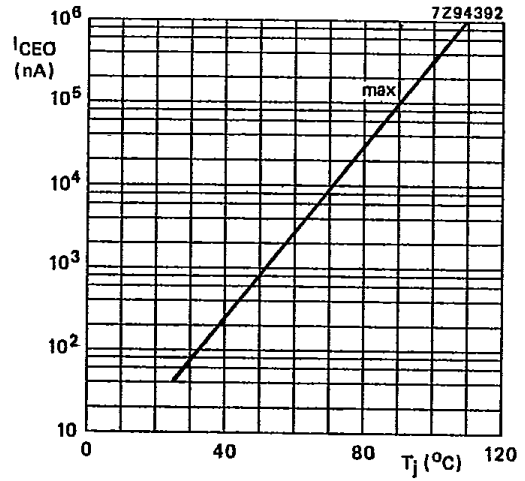

Fig. 13 $V_{CE} = 10 V$.

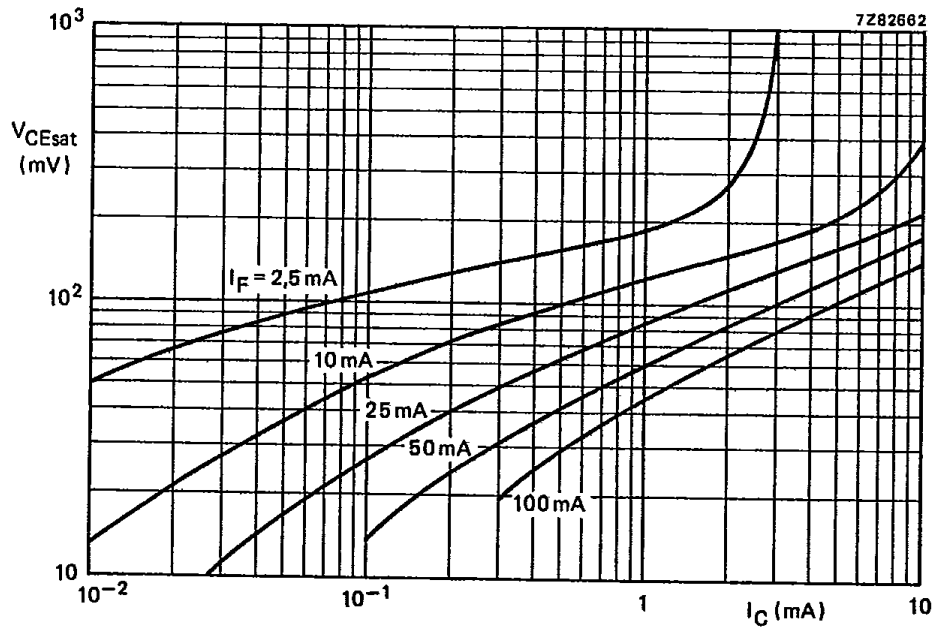

Fig. 14 $T_{amb} = 25^{\circ}C$; typical values.